

B2/2

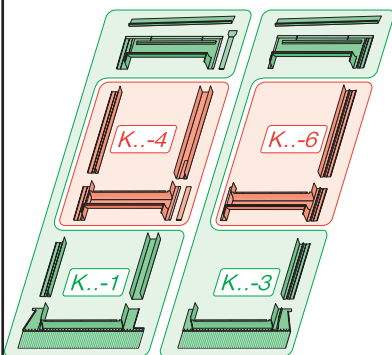

B3/2

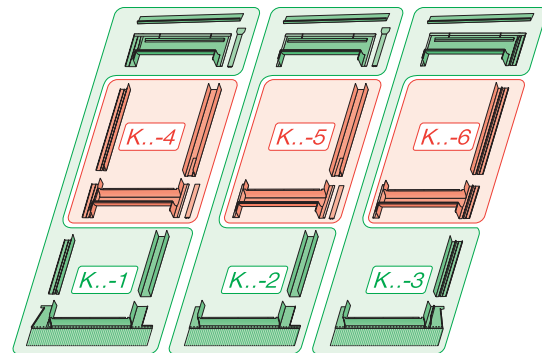

B4/2

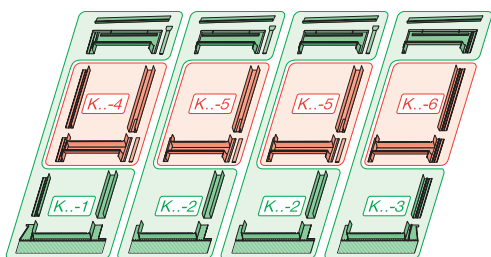

B2/3

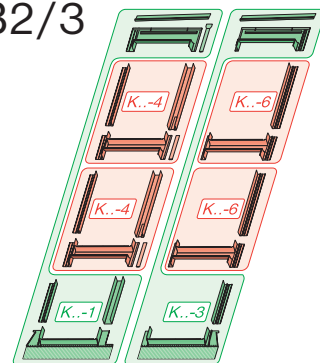

B3/3

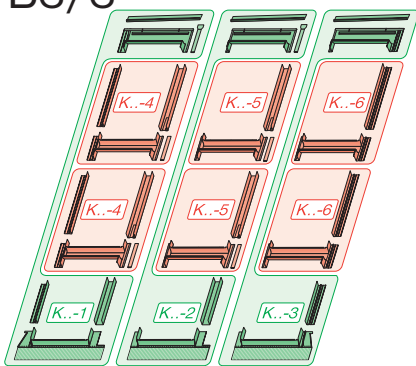

B4/3

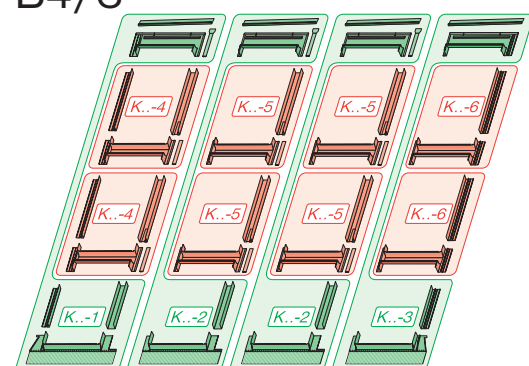

# B 3/2

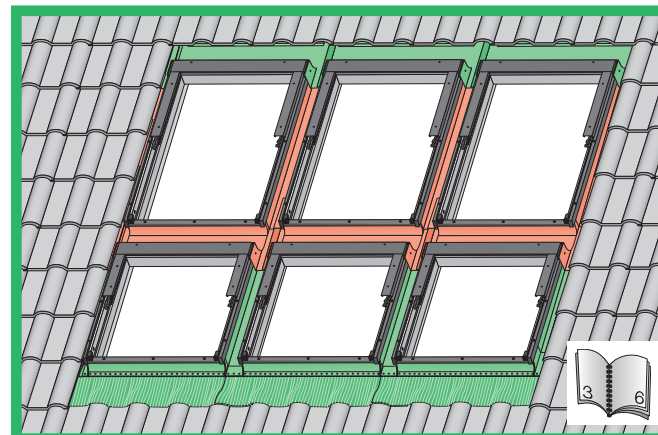

**KHN+KXN**  
**KHV+KXV**

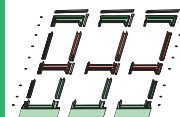

max 90mm

**KZN+KXN**  
**KZV+KXV**  
**KZJ+KXJ**

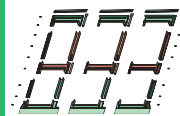

max 45mm

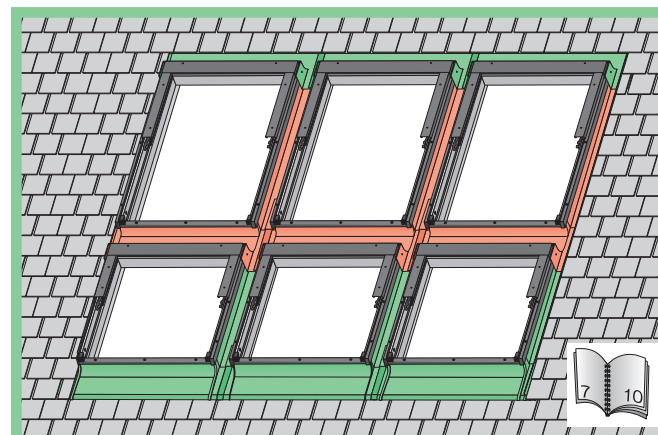

**KSN+KXN**  
**KSV+KXV**  
**KSJ+KXJ**

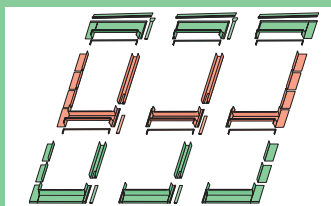

max 5mm

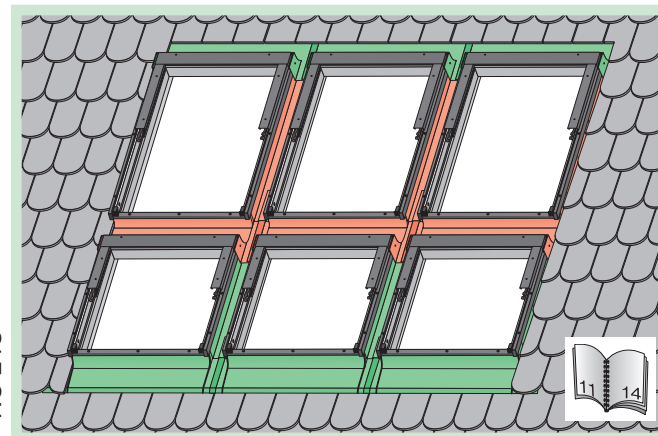



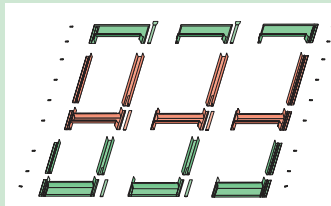

**KLN<sub>(1-3)</sub>+KLN<sub>(4-6)</sub>**  
**KLV<sub>(1-3)</sub>+KLV<sub>(4-6)</sub>**  
**KLJ<sub>(1-3)</sub>+KLJ<sub>(4-6)</sub>**



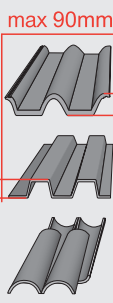
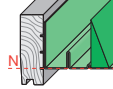

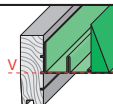

max 15mm (N)  
max 5mm (V)  
max 5mm (J)

NC 248

 <p>max 90mm</p>	<p><b>KHN-1+KHN-2+KHN-3+</b>  <b>KXN-4+KXN-5+KXN-6</b></p>		 <p>15°-90°</p>
	<p><b>KHV-1+KHV-2+KHV-3+</b>  <b>KXV-4+KXV-5+KXV-6</b></p>		 <p>15°-90°</p>
	<p>-</p>	-	-

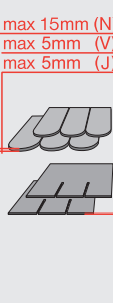
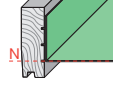
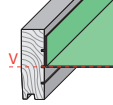
 <p>max 45mm</p>	<p><b>KZN-1+KZN-2+KZN-3+</b>  <b>KXN-4+KXN-5+KXN-6</b></p>		 <p>15°-90°</p>
	<p><b>KZV-1+KZV-2+KZV-3+</b>  <b>KXV-4+KXV-5+KXV-6</b></p>		 <p>15°-90°</p>
	<p><b>KZJ-1+KZJ-2+KZJ-3+</b>  <b>KXJ-4+KXJ-5+KXJ-6</b></p>		 <p>20°-90°</p>

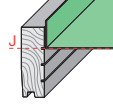
 <p>max 5mm</p>	<p><b>KSN-1+KSN-2+KSN-3+</b>  <b>KXN-4+KXN-5+KXN-6</b></p>		 <p>15°-90°</p>
	<p><b>KSV-1+KSV-2+KSV-3+</b>  <b>KXV-4+KXV-5+KXV-6</b></p>		 <p>15°-90°</p>
	<p><b>KSJ-1+KSJ-2+KSJ-3+</b>  <b>KXJ-4+KXJ-5+KXJ-6</b></p>		 <p>20°-90°</p>

 <p>max 15mm (N)  max 5mm (V)  max 5mm (J)</p>	<p><b>KLN-1+KLN-2+KLN-3+</b>  <b>KLN-4+KLN-5+KLN-6</b></p>		 <p>15°-90°</p>
	<p><b>KLV-1+KLV-2+KLV-3+</b>  <b>KLV-4+KLV-5+KLV-6</b></p>		 <p>15°-90°</p>
	<p><b>KLJ-1+KLJ-2+KLJ-3+</b>  <b>KLJ-4+KLJ-5+KLJ-6</b></p>		 <p>20°-90°</p>

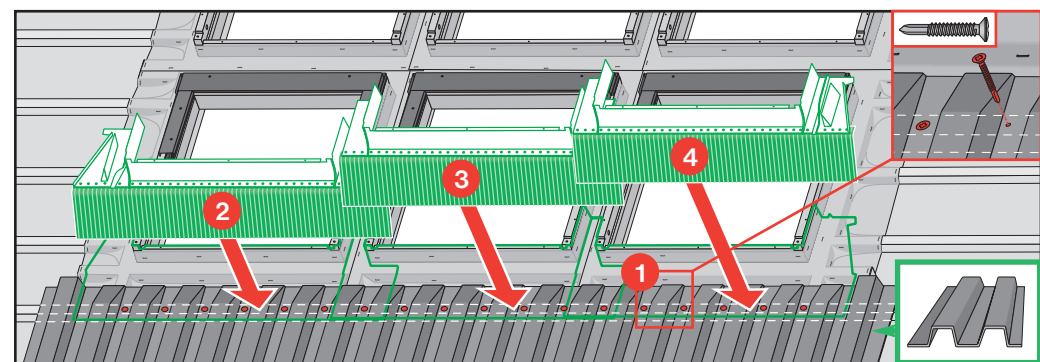
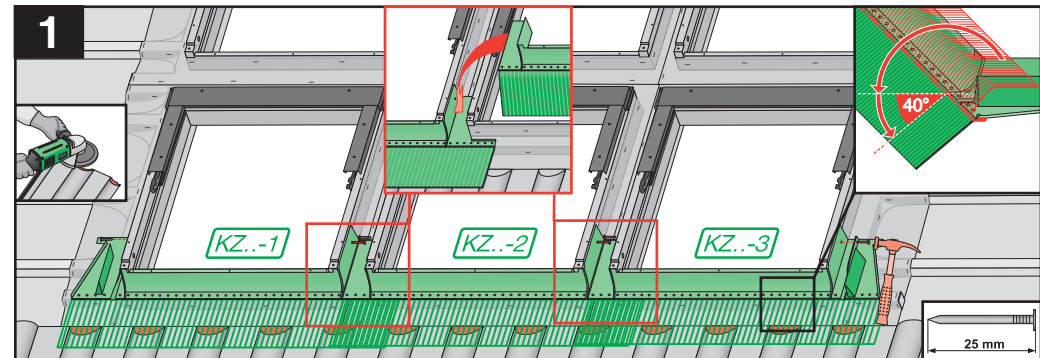
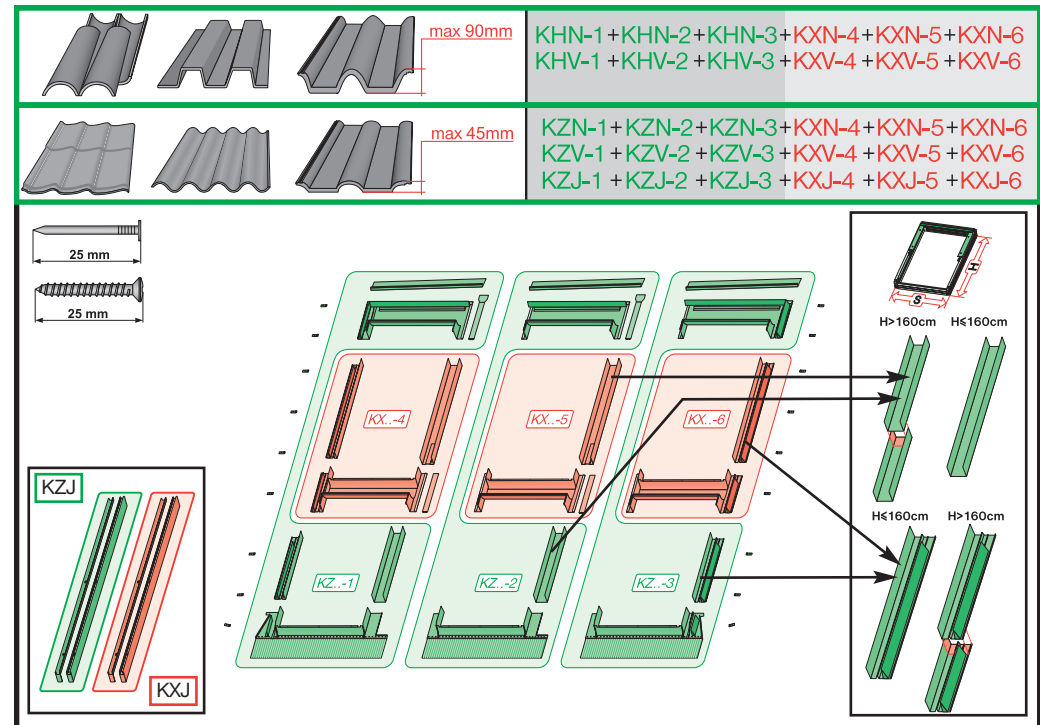

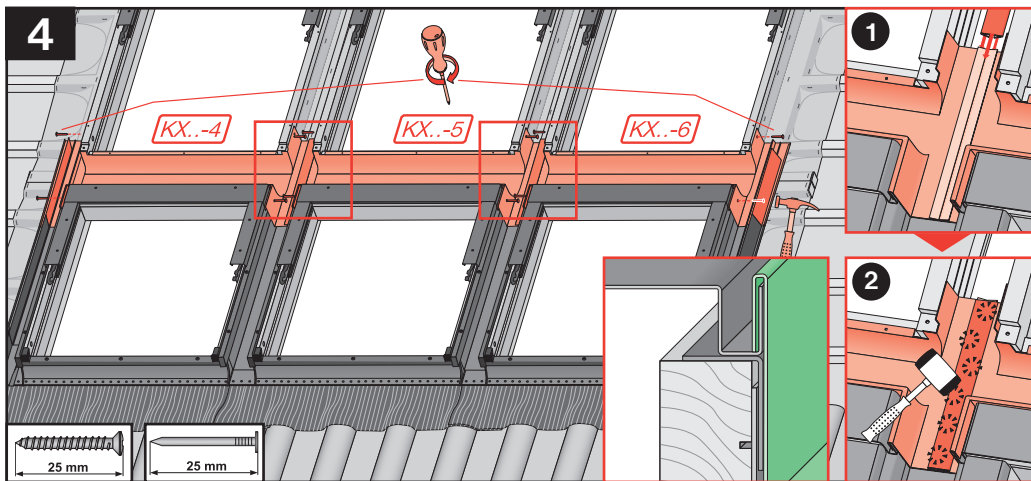
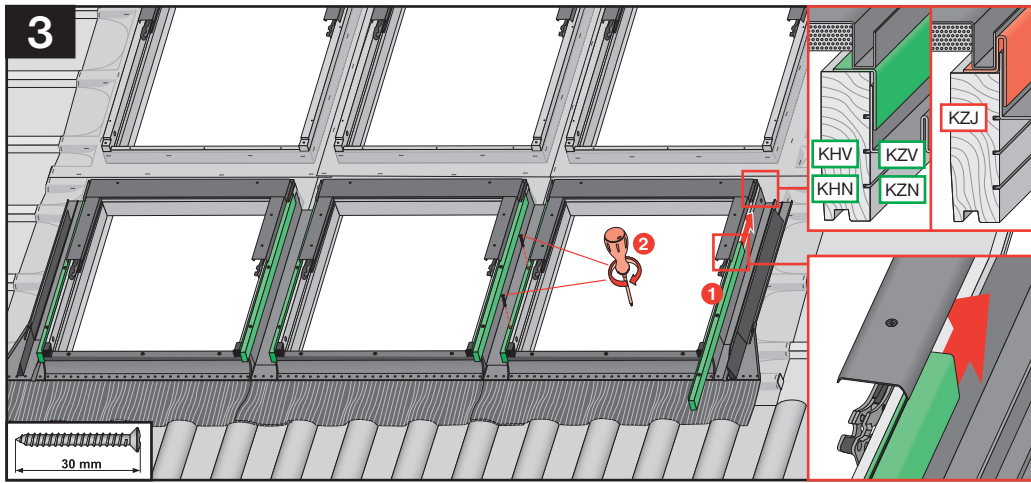
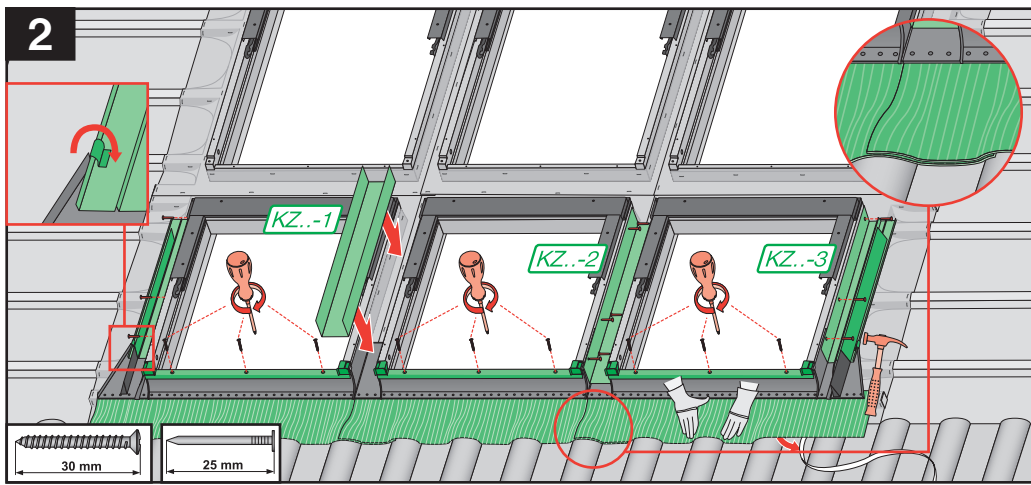

4

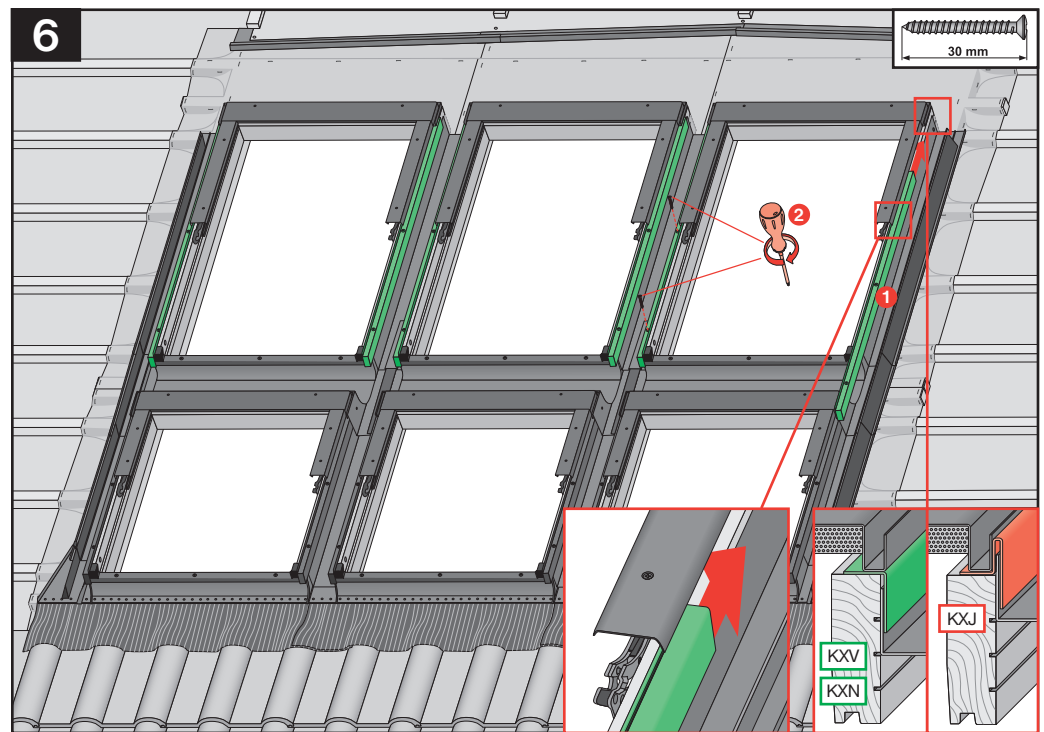
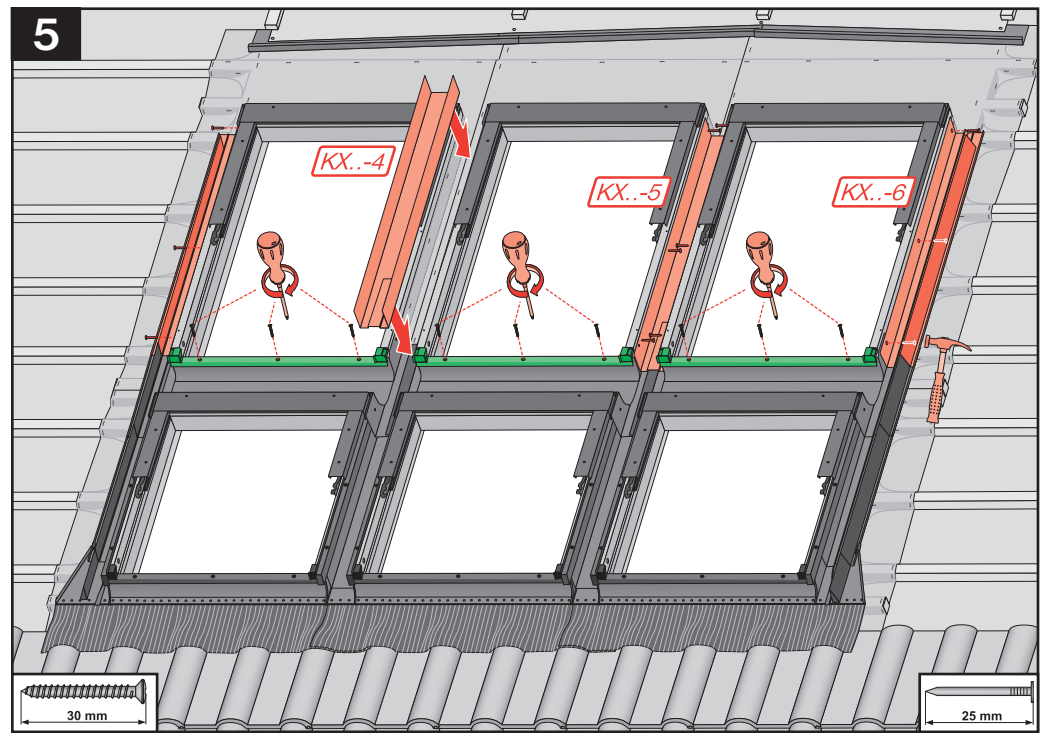

5

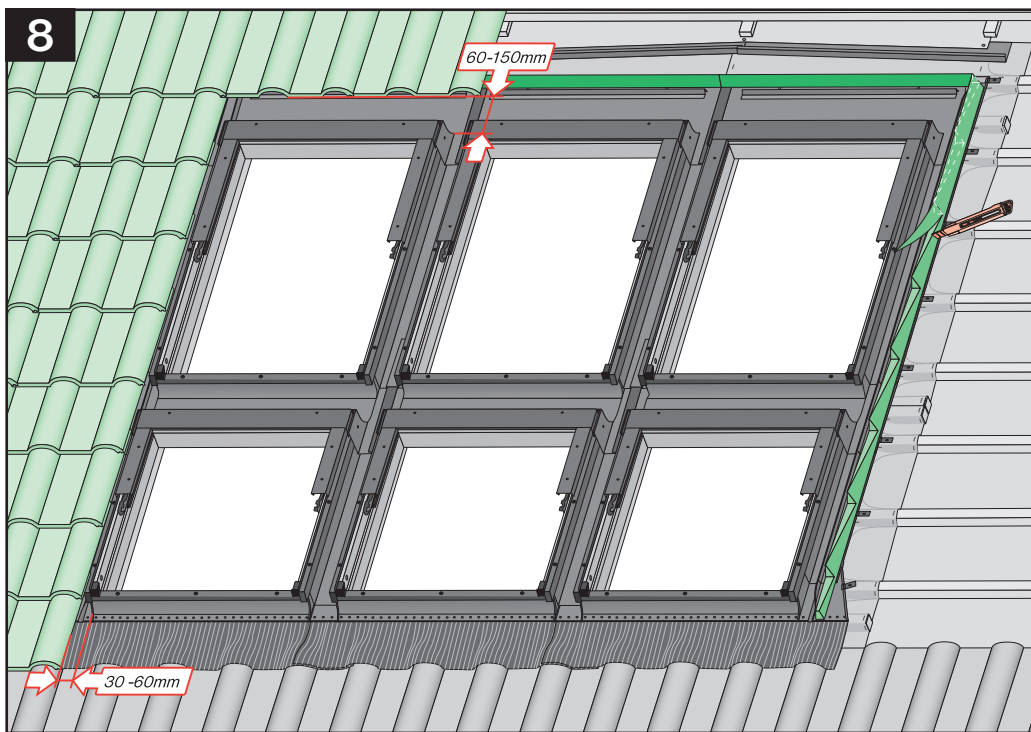
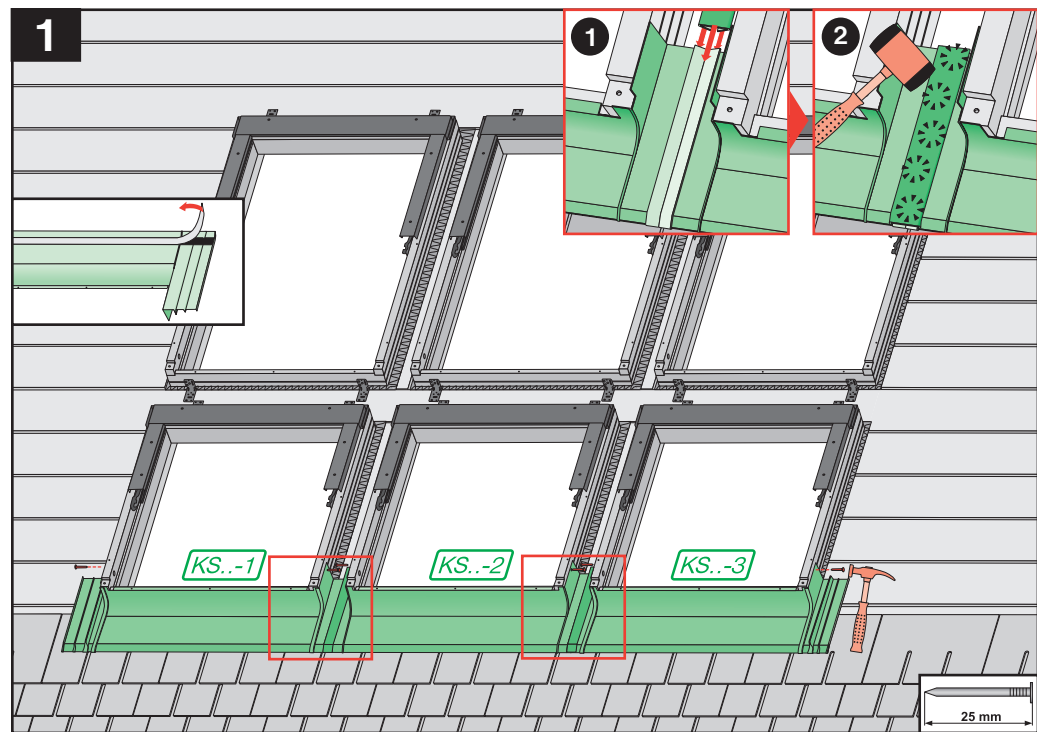
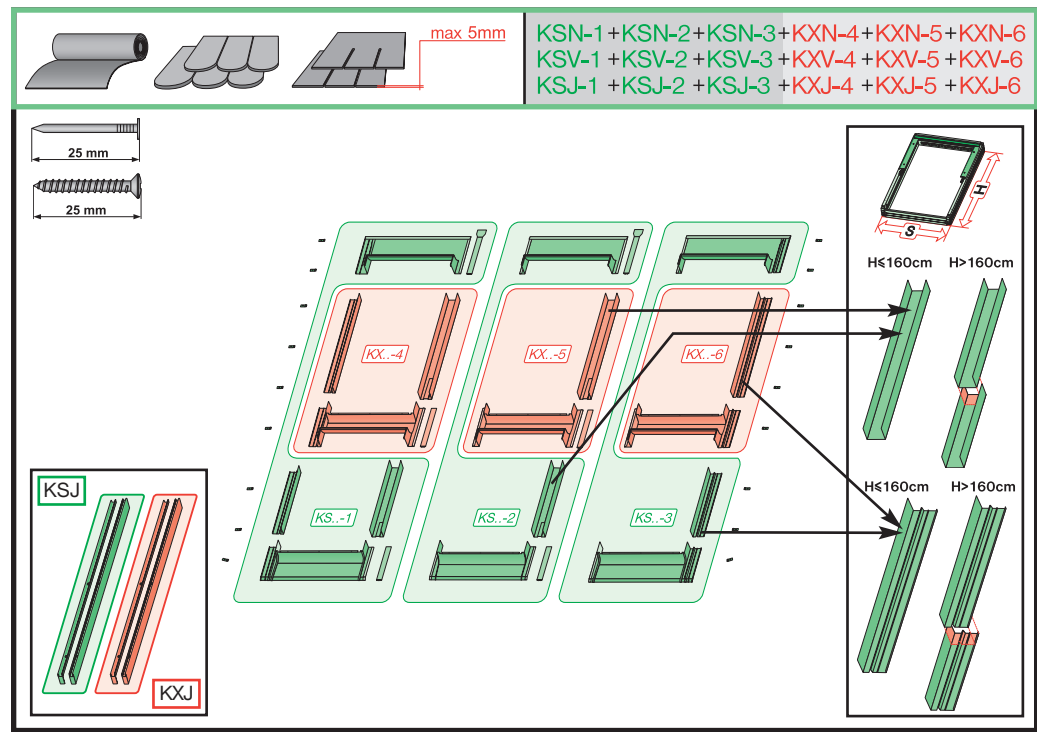
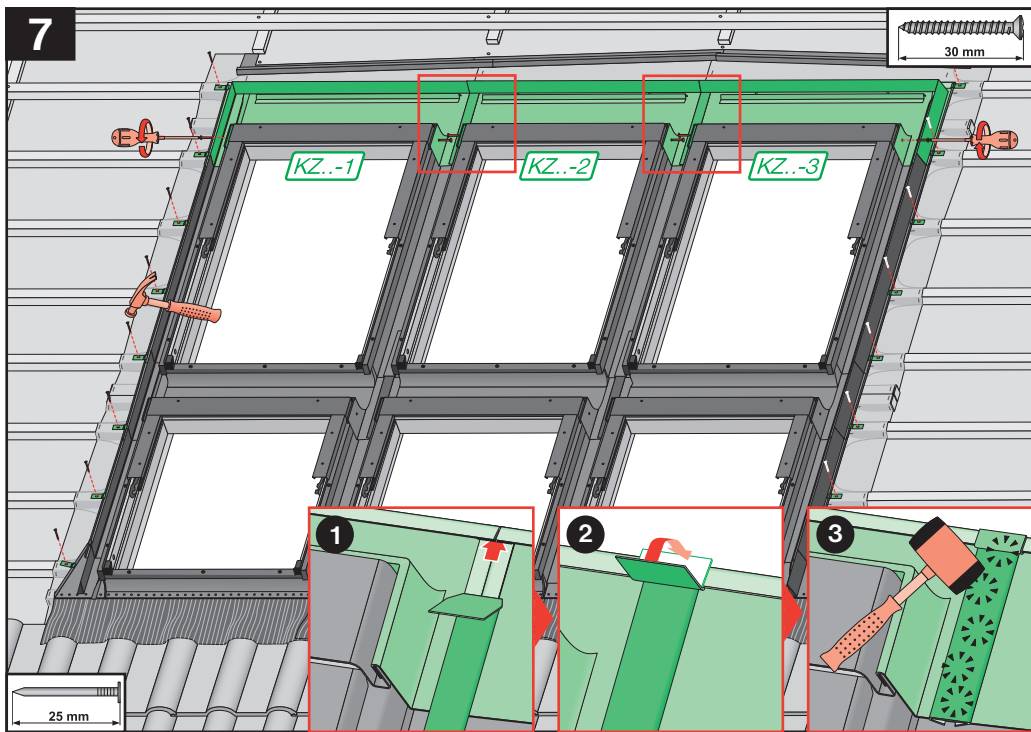

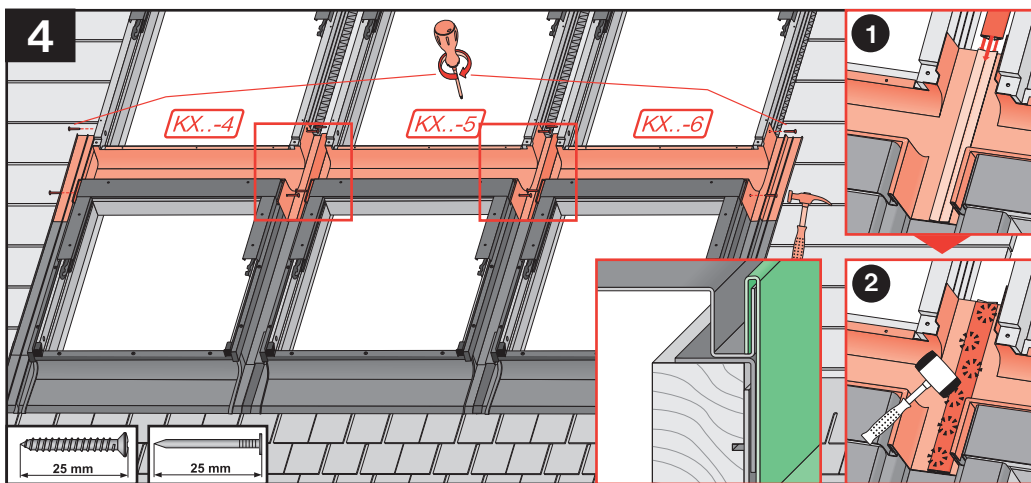
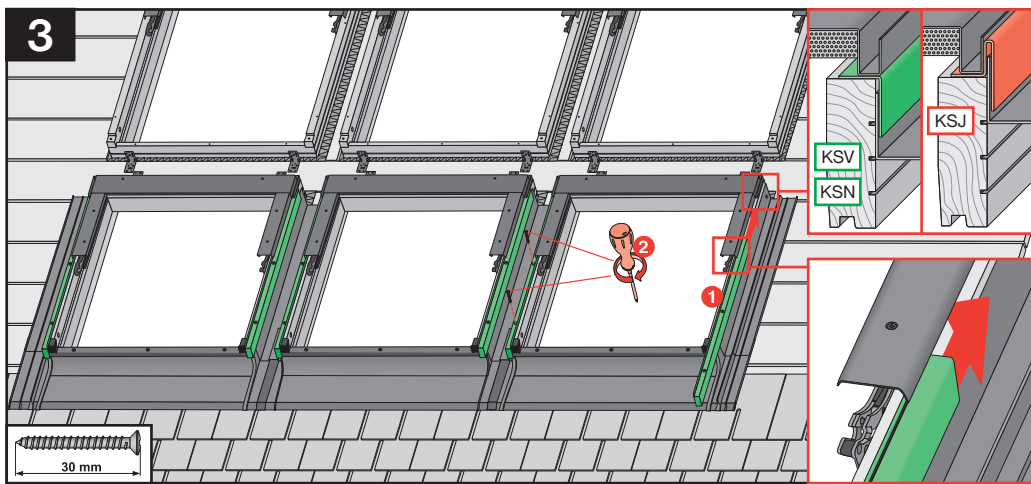
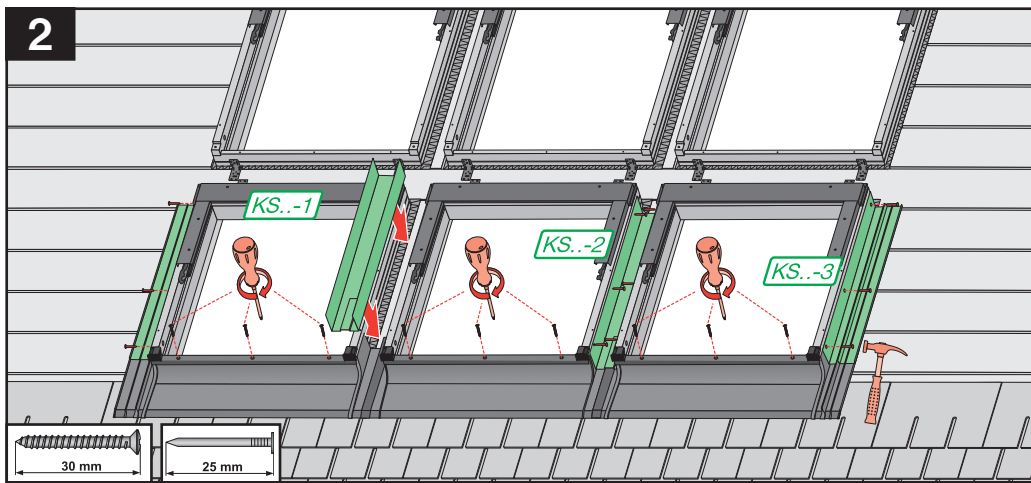

8

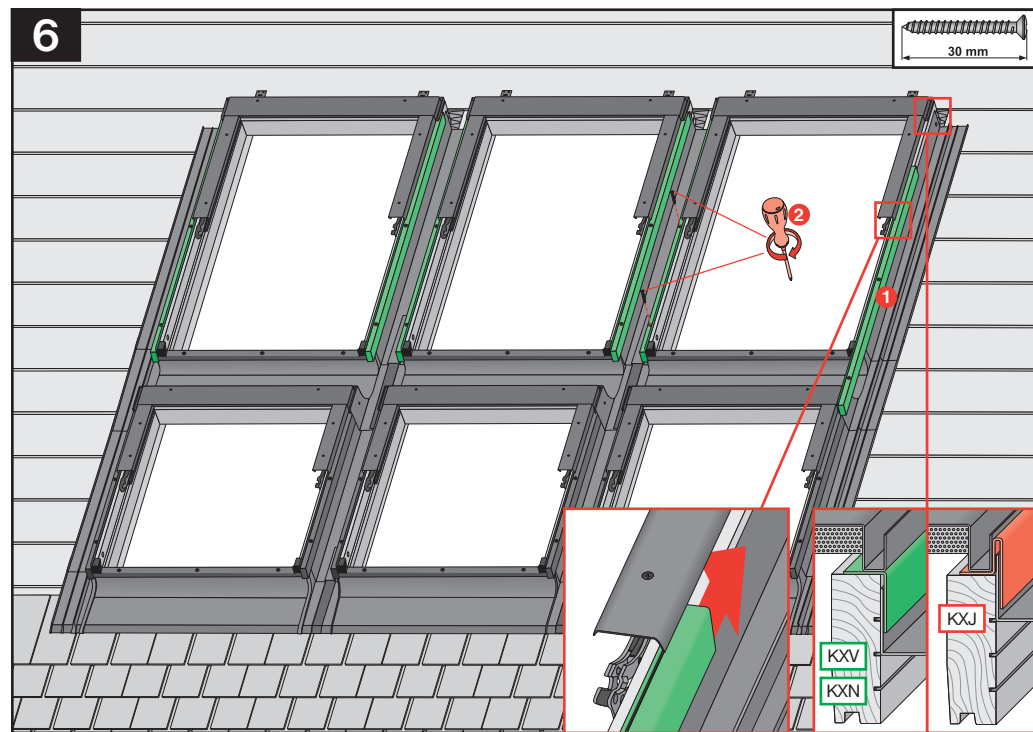
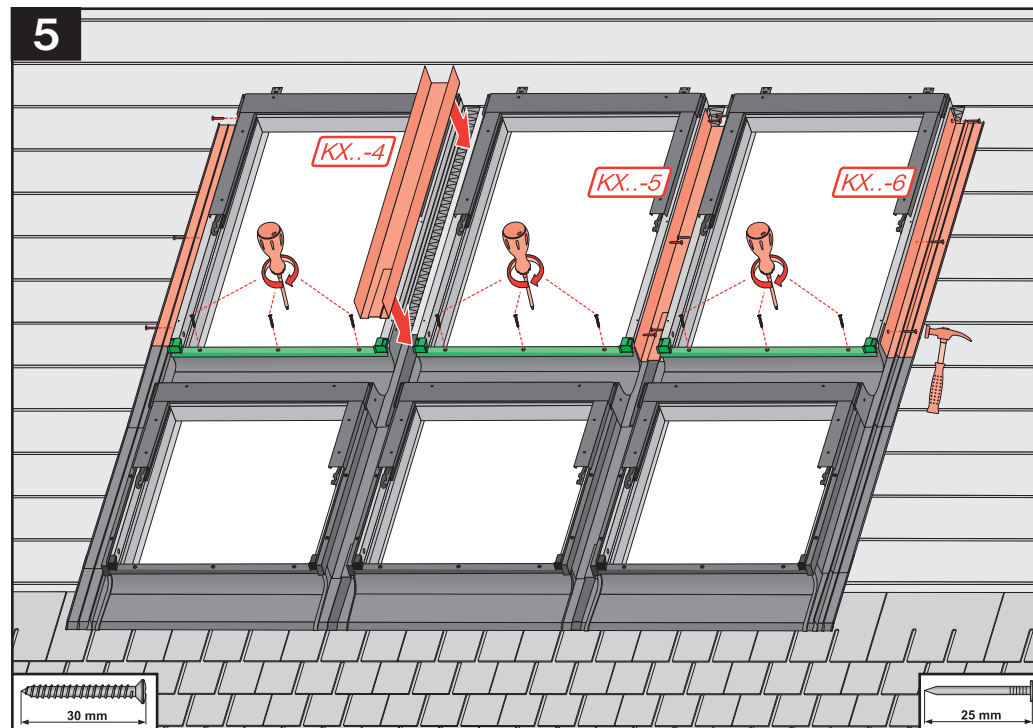

9

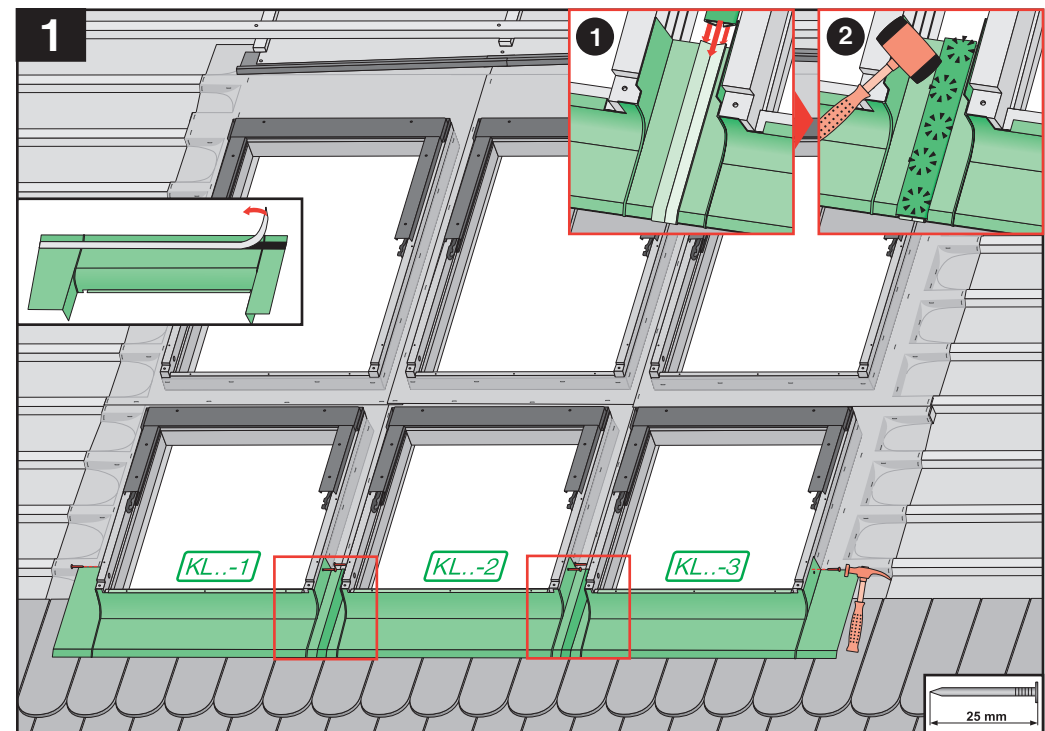
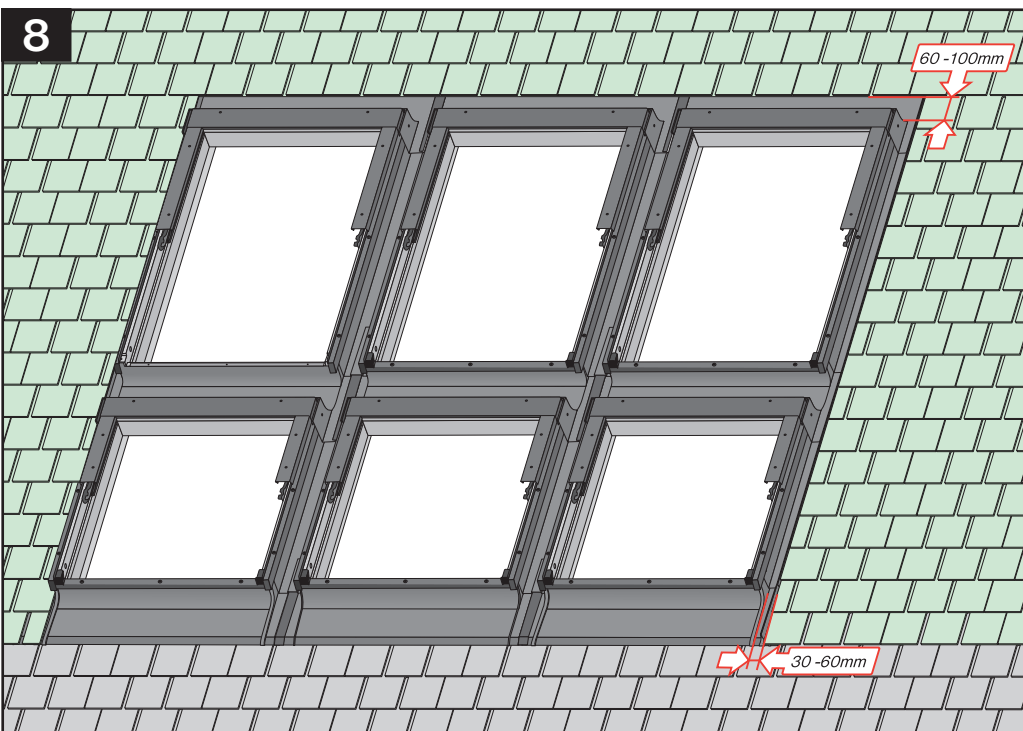
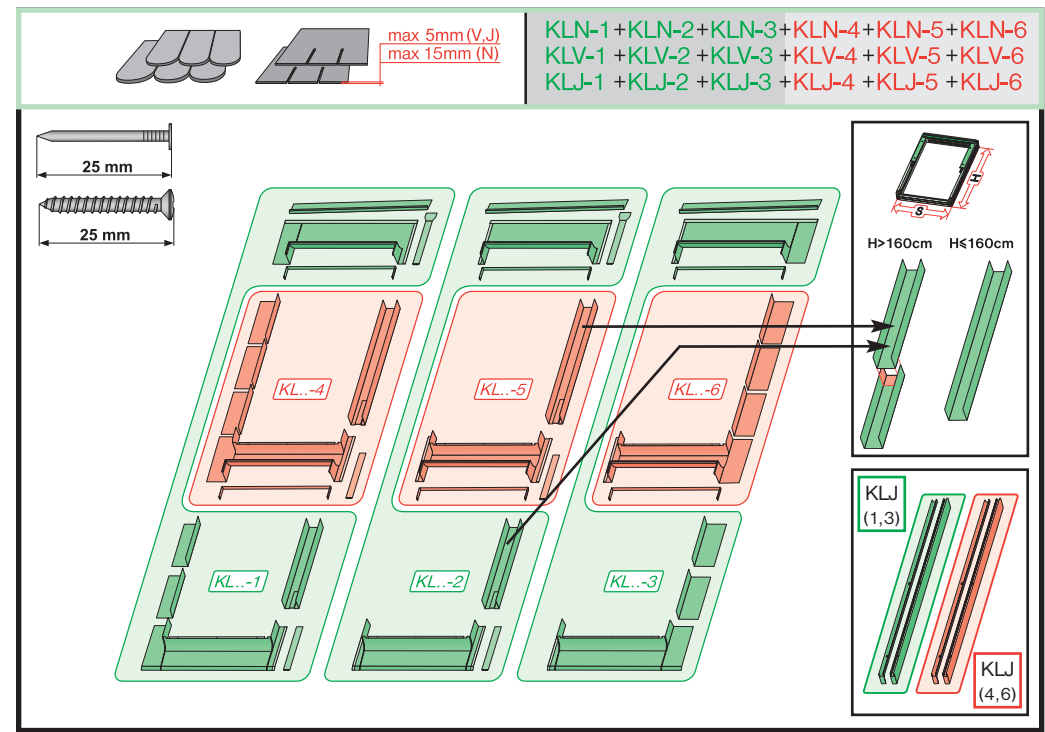
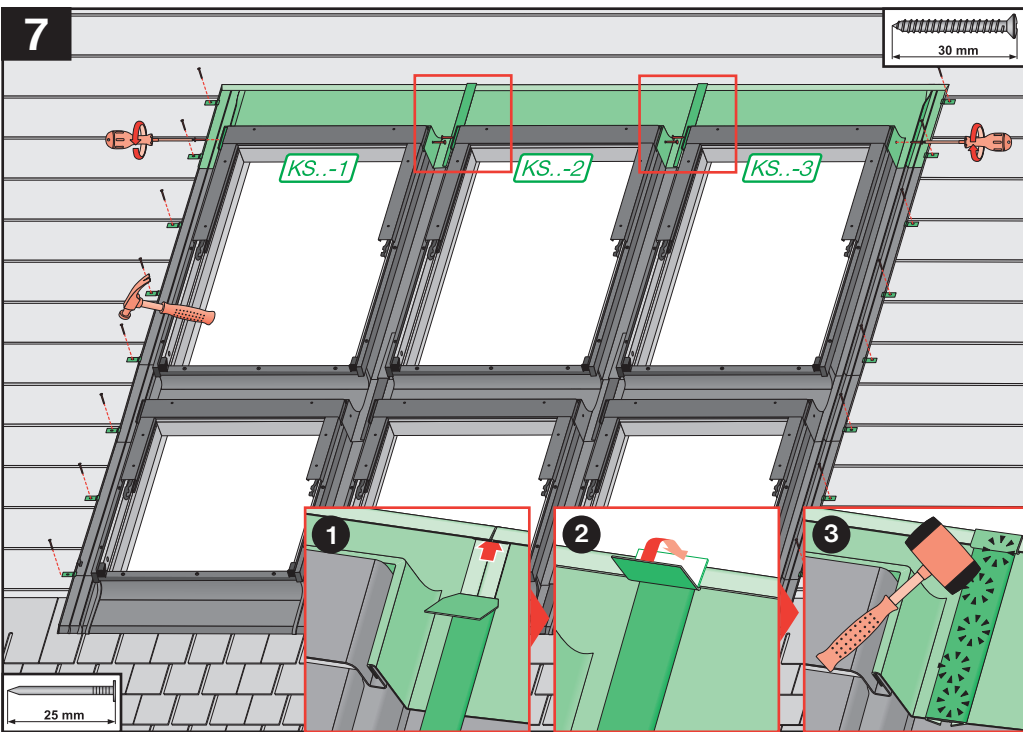

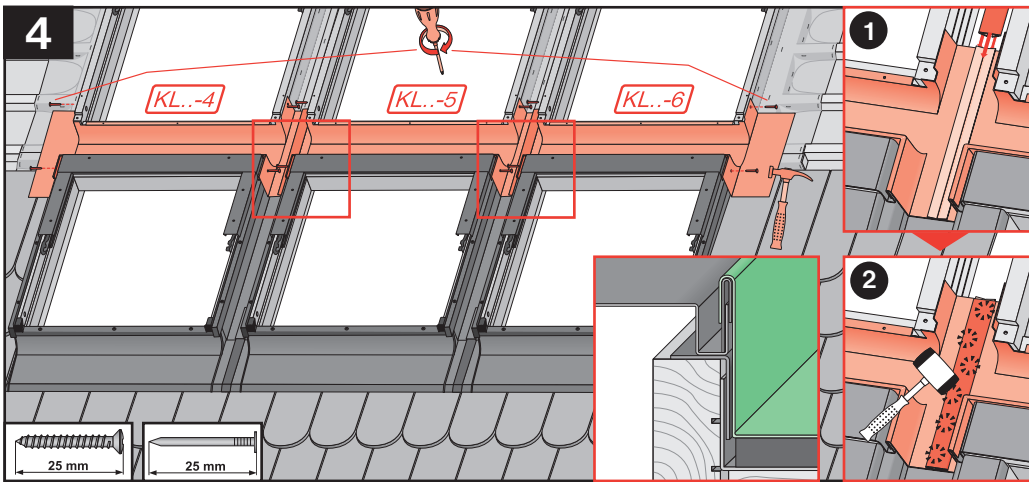
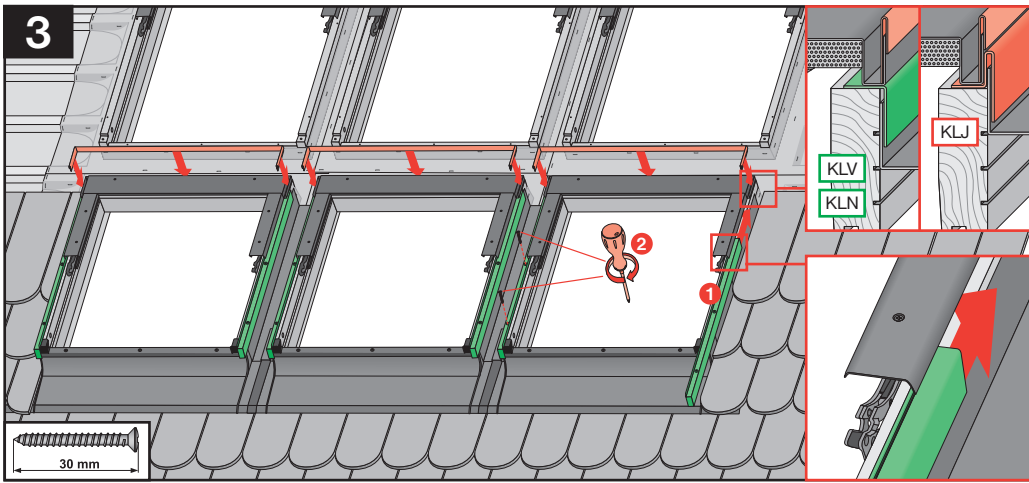
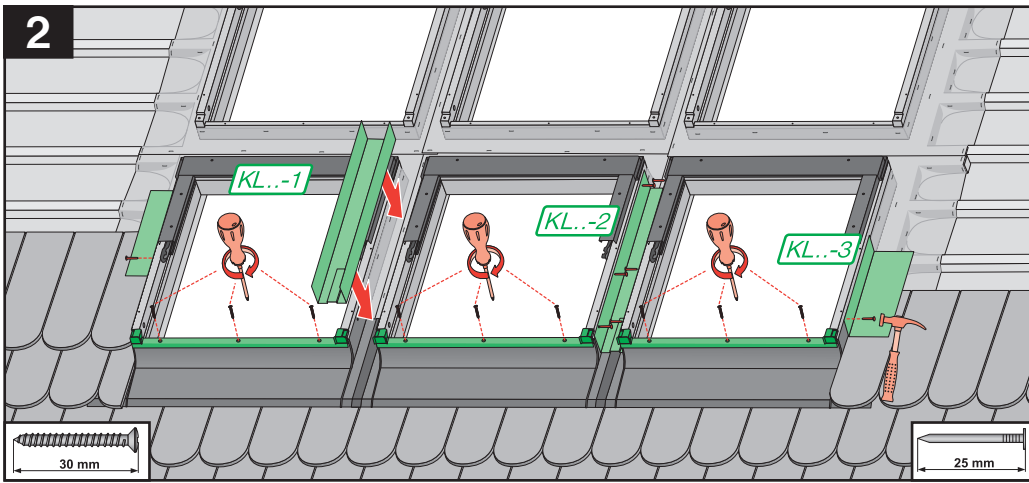

12

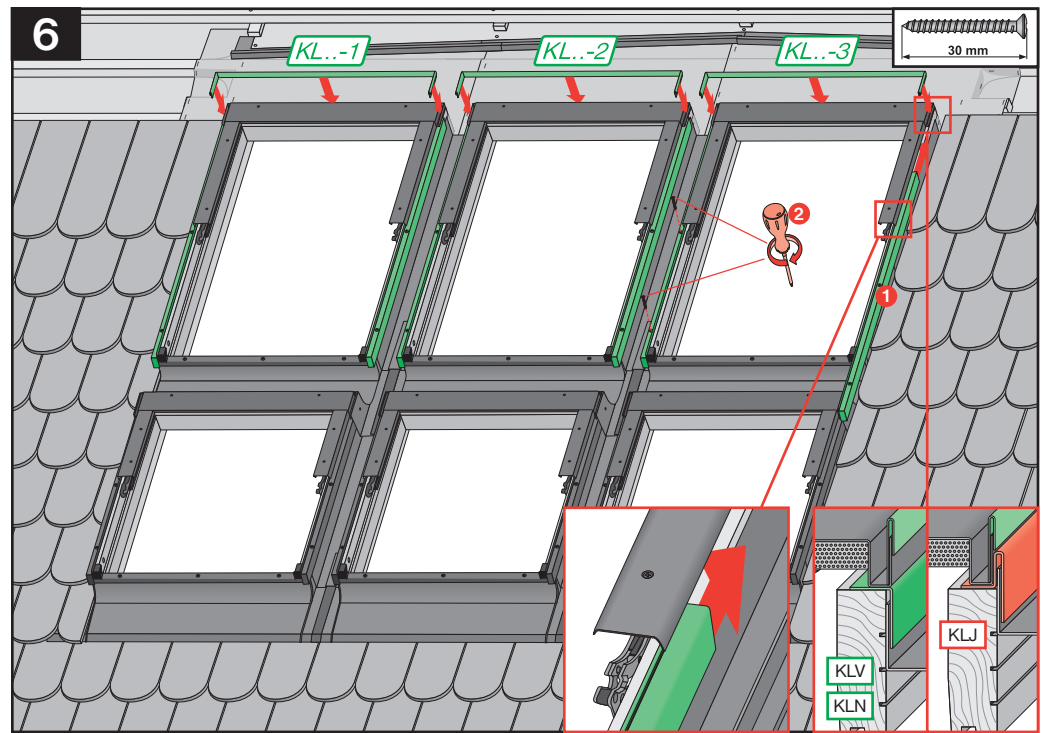
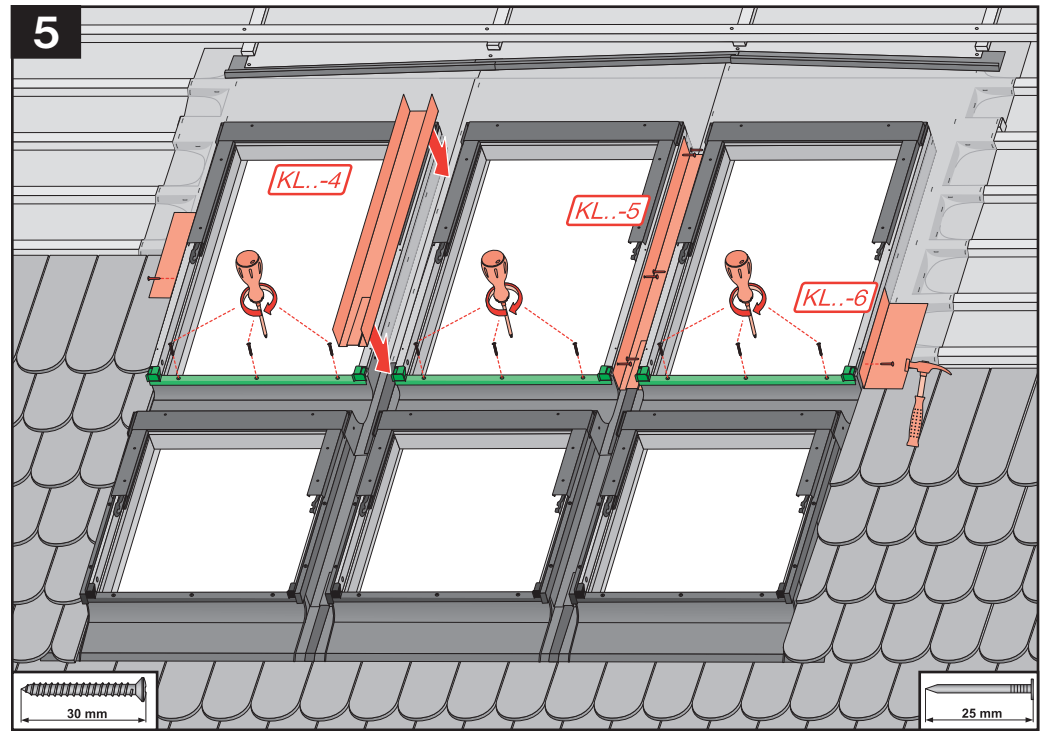

13

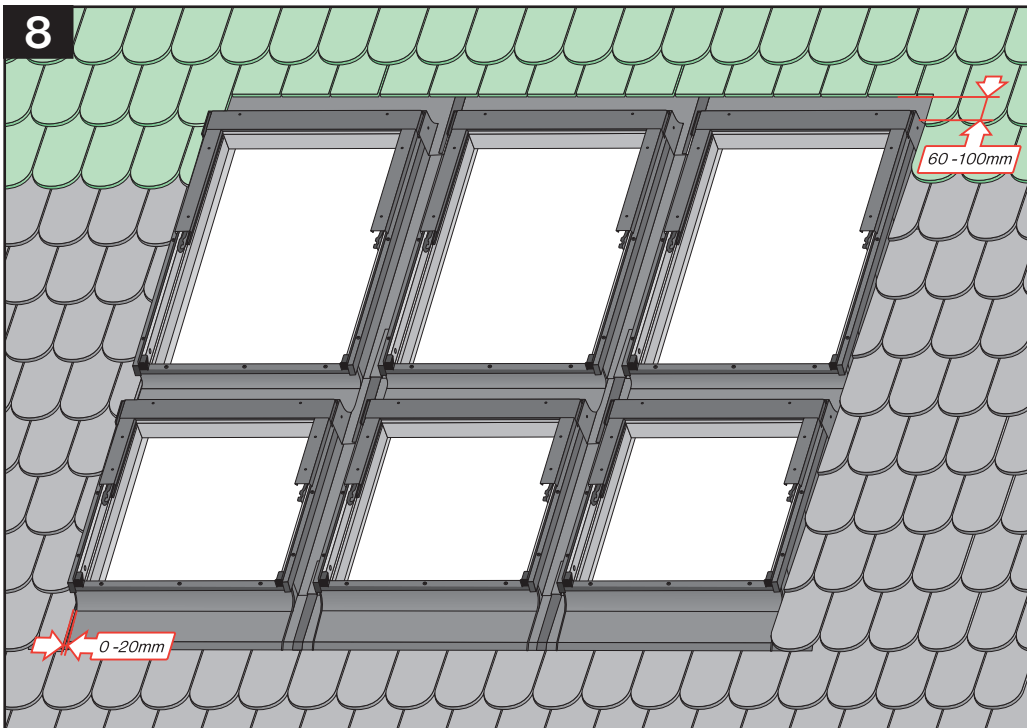
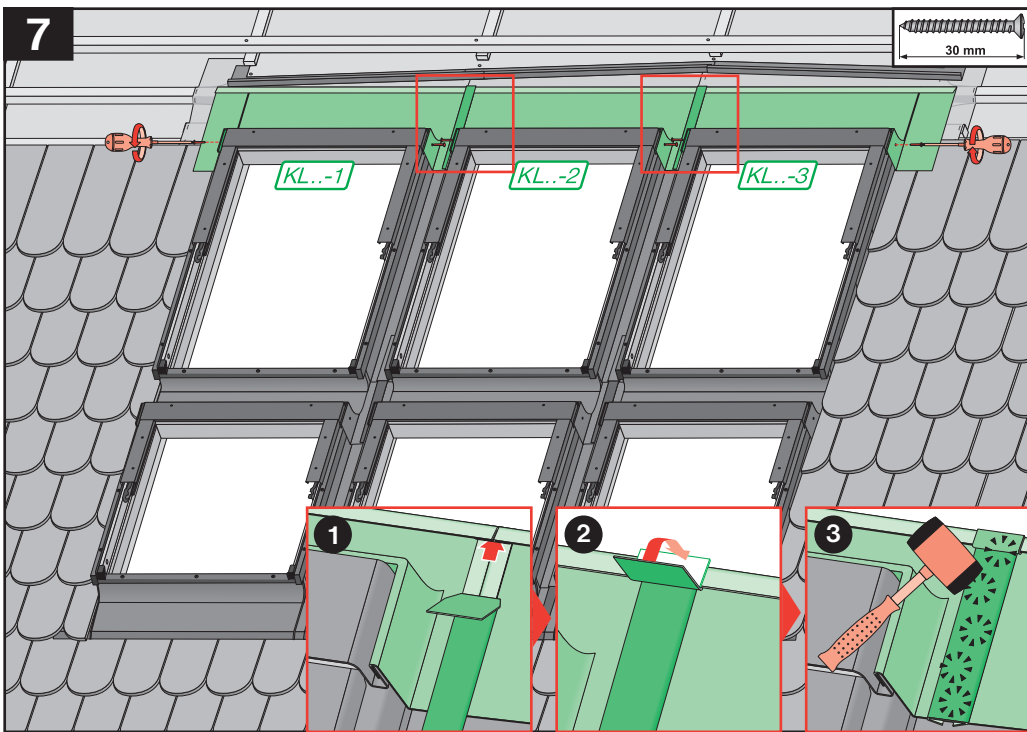

**Мир Кровли**

+7 (495) 981 19 21

[www.krovlja.ru](http://www.krovlja.ru)